

MINI 2 3D SCANNER

Quick Start Guide

V1.0

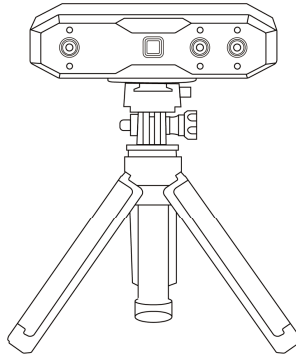

REVOPOINT

Thank you for choosing the Revopoint 3D scanner! Please carefully read this guide before your first scan.

Begin by downloading the **Revo Scan** software for your MINI 2 3D Scanner. For Windows, macOS and Android users, visit the Support section on Revopoint's website at www.revopoint3d.com to download. iOS users, find **Revo Scan** on the Apple App Store to download.

Go to the bottom of Download page to get the latest Quick Start Guide and User Manual. You can also follow our YouTube account, Revopoint 3D, for tutorial videos. This content is subject to change. Please refer to the latest version.











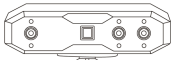

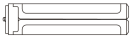

Please keep the scanner away from water and any other liquids, and avoid bashing the scanner. This product's operating environment temperature range is 0°C to 40°C (32°F to 104°F). Please operate the product appropriately and only in situations limited to this temperature range.

Table of Content

What's in the box?	1
Product Profile	2
System Requirements	3
Connecting MINI 2 to a PC	4
Via USB Cable	4
Via Wi-Fi	5
Connecting MINI 2 to Phones	7
To Android Phones via USB Cable	7
To Android or iOS Phones via Wi-Fi	9
Mini Turntable Connection	11
Scanning Tips	12
Your First Scan	14

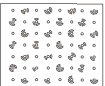
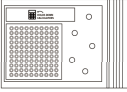
Your First Scan Using Revo Scan (PC)	14
Your First Scan Using Revo Scan (Android)	16
Your First Scan Using Revo Scan (iOS)	18
 Sharing Models from a Phone to a PC	21
IC Warning	22
FCC Warning	23

What's in the box?

<p>1</p>  <p>MINI 2 3D Scanner</p>	<p>2</p>  <p>Quick Mount Kit</p>	<p>3</p>  <p>Tripod</p>	<p>4</p>  <p>Phone Holder</p>
<p>5</p>  <p>USB Type-A to C Cable</p>	<p>6</p>  <p>2-in-1 Mobile Cable</p>	<p>7</p>  <p>USB Type-C Adapter</p>	<p>8</p>  <p>Mini Turntable</p>
<p>9</p>  <p>Turntable Topper</p>	<p>10</p>  <p>AgiPPa</p>	<p>11</p>  <p>Carrying Case</p>	<p>12</p>  <p>Calibration Board</p>
<p>13</p>  <p>Magic Mat, Markers Glue Tack</p>	<p>14</p>  <p>Turntable Power Cable</p>	<p>15</p>  <p>MINI 2 Quick Start Guide</p>	<p>16 (For Advanced Edition Only)</p>  <p>Dual-axis Turntable</p>

※ For reference only.

Product Profile

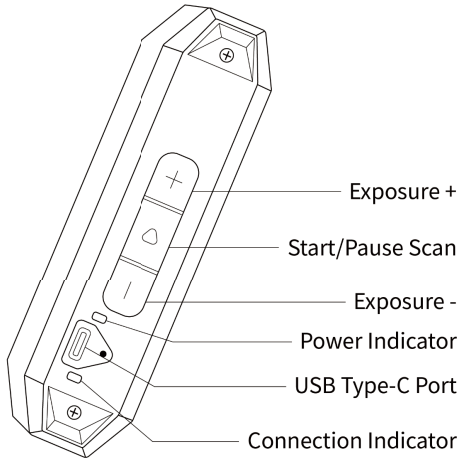
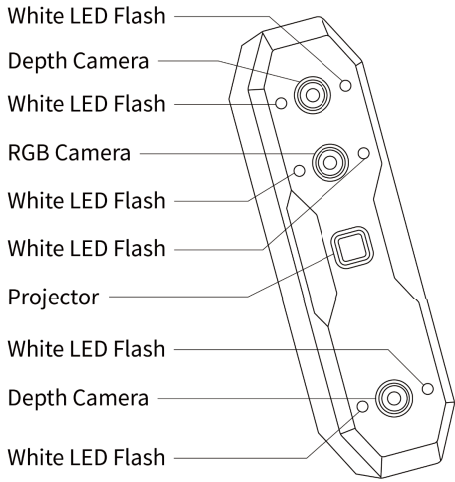

System Requirements

Please download the Revo Scan software before your first scan. The system requirements are as follows:

Windows: Win 10/11 (64-bit) RAM: 8GB or better Processor: Intel Core i5 10th Gen or better	Android: Android 9.0 or better RAM: 6GB or better
Mac with Intel x86 chip: macOS 10.15 and models after Mac with Apple M1/M2 chip: macOS 11.0 and models after RAM: 8GB or better	iPhone: iPhone 8 Plus or models after iPad: 6th generation iPad or models after System Version: iOS 13.0 or better

Scanner Connection

System Mode	PC	Phone	
	Windows/macOS	Android	iOS
USB	✓	✓	✗
Wi-Fi	✓	✓	

Connecting MINI 2 to a PC

Via USB Cable

Step 1: Connect the Quick Mount Kit to the scanner, then screw the Tripod to the Quick Mount Kit.

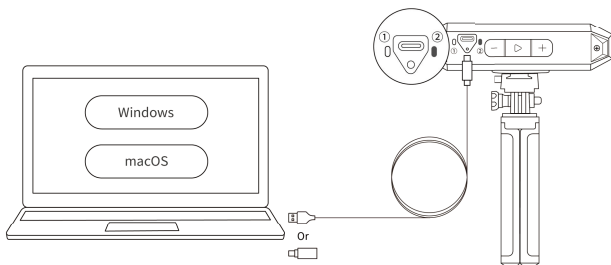
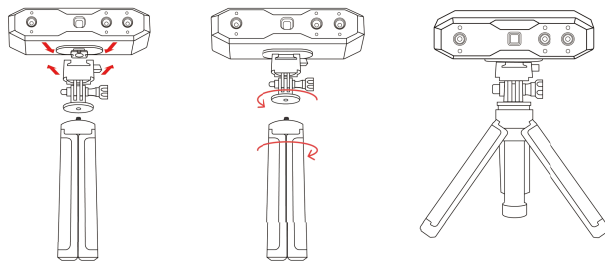

Step 2: Use the USB Type-A to C Cable to connect the scanner to a PC. When the scanner's indicator ② turns solid green, it's powered.

Note: If your PC does not have a USB Type-A port, use the USB Type-C Adapter.

Step 3: Open Revo Scan, when the software shows Scanner Connected and the scanner's indicator ① turns solid blue, it's ready.

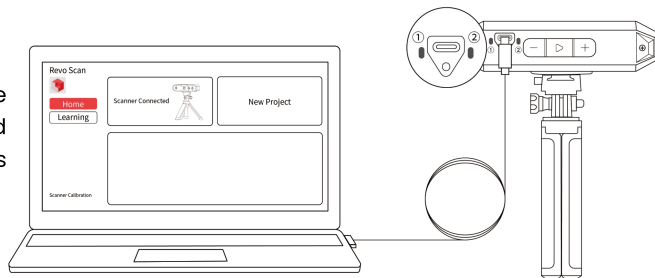

Via Wi-Fi

Step 1: Connect the Quick Mount Kit to the scanner, then screw the Power Bank Handle to the Quick Mount Kit.

Note: The Power Bank Handle can be purchased from the Revopoint online store.

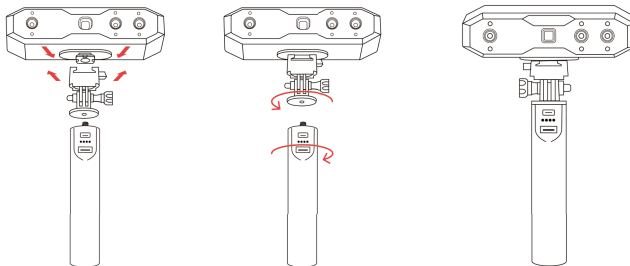

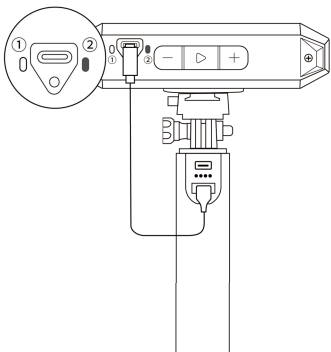

Step 2: Use the USB Type-A to C Cable to connect the scanner and Power Bank Handle. When the scanner's indicator ② turns solid green, it's powered.

Step 3: Search for a Wi-Fi network called **MINI 2-REVO-XXXXXXX** in your PC's Wi-Fi settings, and connect (no password is required).



Wi-Fi

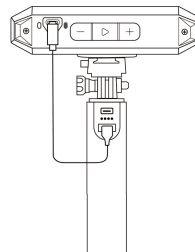

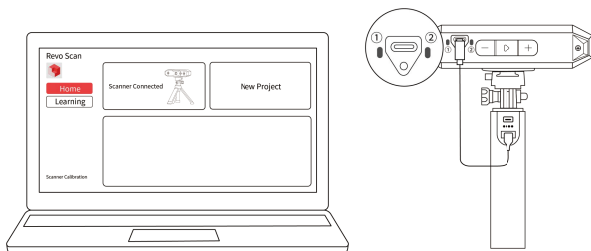

Step 4: Open Revo Scan, when the software shows Scanner Connected and the scanner's indicator ① turns solid blue, it's ready.

Connecting MINI 2 to Phones

To Android Phones via USB Cable

Step 1: Connect the Phone Holder and Power Bank Handle to the scanner.

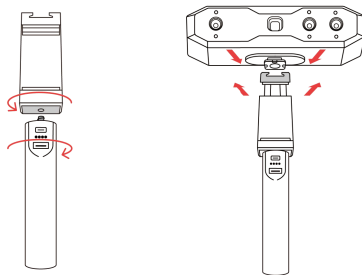

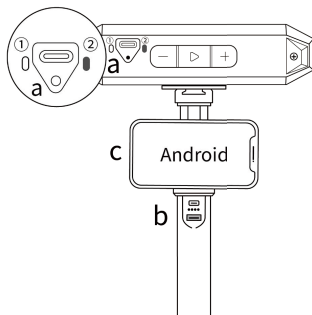
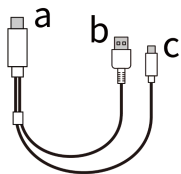

Step 2: Put a phone in the Phone Holder, and use the 2-in-1 Mobile Cable to connect to the ports shown. When the scanner's indicator ② turns solid green, it's powered.

Note: The 2-in-1 Mobile Cable only connects the scanner to Android phones.

Step 3: Open Revo Scan, when the software shows Scanner Connected and the scanner's indicator ① turns solid blue, it's ready.

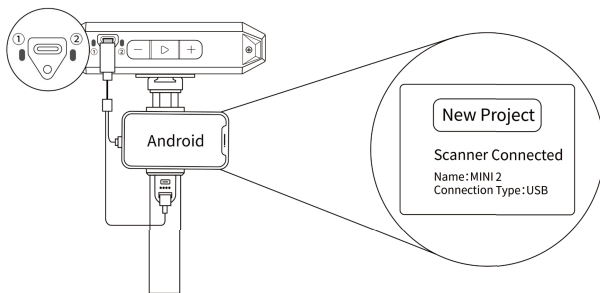

To Android or iOS Phones via Wi-Fi

Step 1: Connect the Phone Holder and Power Bank Handle to the scanner.

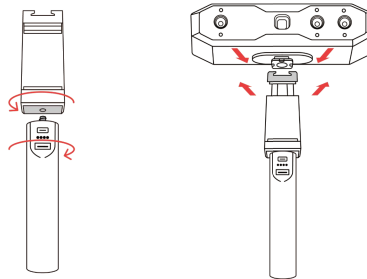
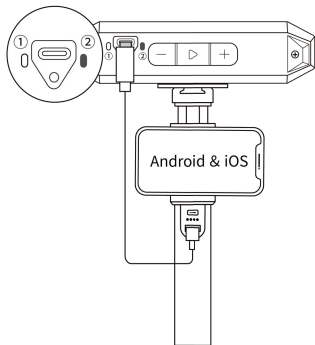

Step 2: Put a phone in the Phone Holder, and use the USB Type-A to C Cable or 2-in-1 Mobile Cable to connect the scanner to the Power Bank Handle. When the scanner's indicator ② turns solid green, it's powered.

Step 3: Search for a Wi-Fi network called **MINI 2-REVO-XXXXXXXX** in your smartphone's Wi-Fi settings, and connect (no password is required).

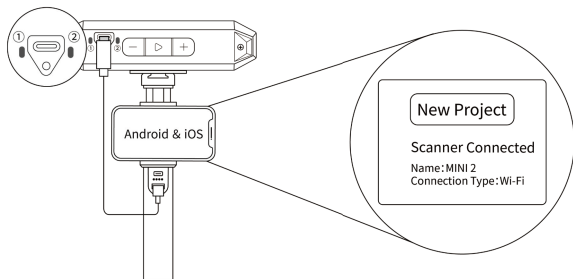
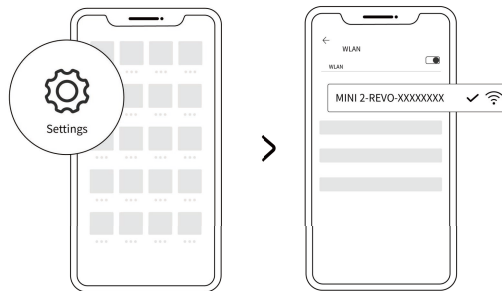

Step 4: Open Revo Scan, when the software shows Scanner Connected (iOS devices will show the scanning preview window) and the scanner's indicator ① turns solid blue, it's ready.

Mini Turntable Connection

Step 1: Connect the turntable to a PC or a socket via the turntable's power cable. When the indicator turns solid green, it's powered.

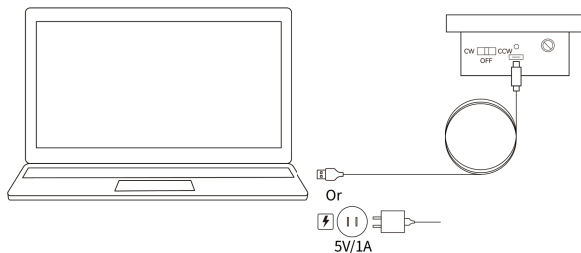

Step 2 : Place the object on the turntable. Flick the switch left or right to adjust the turntable's rotational direction, and twist the dial to adjust the rotation speed.

Note: For Dual-axis Turntable users, visit the Support section on Revopoint's website at www.revopoint3d.com to download its Quick Start Guide.

Scanning Tips

- ① Please scan indoors and ensure only the object to be scanned is shown in the Depth Camera's preview window. Ensure the object is evenly lit if you need a color model.
- ② Use scanning spray when scanning transparent, dark, and reflective objects.
- ③ Use scanning spray or adjust the Depth Camera's exposure when scanning objects with colored surfaces that absorb blue light.



Note: Scanning spray can be purchased from the Revopoint Store on our website.

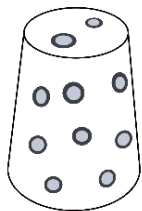

Stick Markers

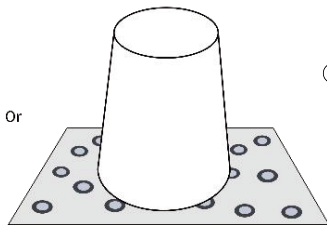

Use Magic Mat

- ④ Please stick markers irregularly on the object's surface or use the Magic Mat when scanning featureless objects like balls and cylinders, and choose Marker Tracking in Scan Settings - Tracking Mode in Revo Scan.

- ⑤ Adjust the tripod to a suitable height and aim the scanner at the object. The distance between the scanner and the object can be between 120 – 250 mm. In the 3D scanning interface in Revo Scan, refer to the distance indicator bar to ensure an excellent distance between the scanner and the object. For handheld scans, move the scanner slowly and steadily around the object.

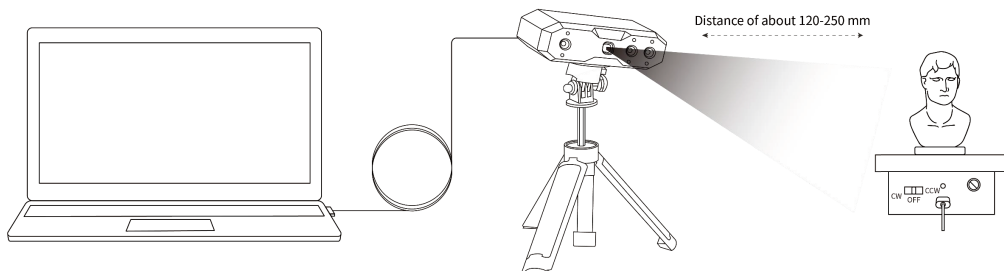

Note: For best accuracy, recalibrate the scanner in an environment that's at the same temperature as your scanning environment.

The scanning accuracy may be affected if the scanner is bashed by accident. In this case, please get in touch with us to help you recalibrate the scanner with the Calibration Board. If the accuracy still cannot reach the standard accuracy after recalibration, please return the scanner for repair.







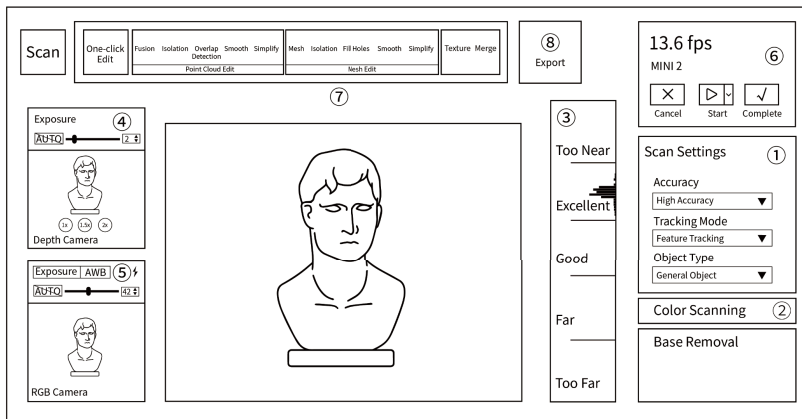

Your First Scan

Your First Scan Using Revo Scan (PC)

After the scanner is connected, click the **New Project** button on Revo Scan's Home Page, then set parameters and start your scan using the following steps:



※ Please refer to the interface of Revo Scan.

- ① Choose Accuracy, Tracking Mode, and Object Type according to your requirements.
- ② Toggle **Color Scanning** if you need a color model.
- ③ Move the scanner closer or further away from the object until the scanning distance indicator bar shows **Excellent** or **Good**.
- ④ Click the  button for the Depth Cameras' exposure to be set automatically, or you can turn off the  exposure and change the exposure by dragging the slider until there are as few blue and red areas on the object in the Depth Camera preview window as possible.
- ⑤ You also must adjust the RGB Camera's exposure when doing a color scan. Click the  button for the exposure to be set automatically, or you can turn off the  exposure and adjust the exposure by dragging the slider until the object's color in the RGB preview window is clear and sharp.
- ⑥ Click the  button to begin your scan. While scanning, hold the scanner steady and move slowly. Try not to scan the same areas repeatedly. You can click the  button to stop and check your model anytime during your scan. If the model is incomplete, click the  button to continue your scan. Click the  button to finish the scan when the model is complete.
- ⑦ Click **One-click Edit** to process the model automatically, or manually edit the model using the Fusion, Mesh, Texture (only for color models) settings, and other tools if you need a more detailed model.
- ⑧ After post-processing, export the model in PLY, OBJ, or STL formats.

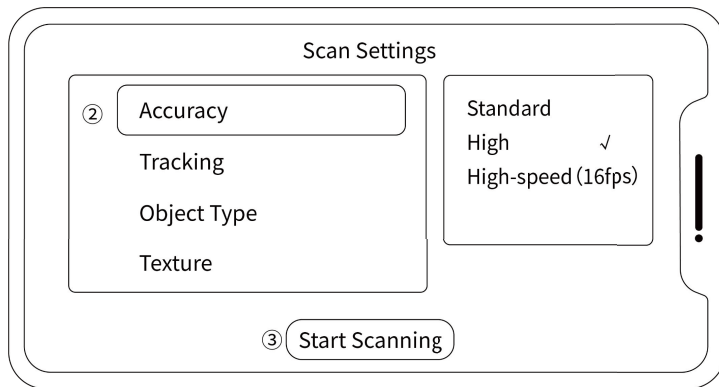

Your First Scan Using Revo Scan (Android)

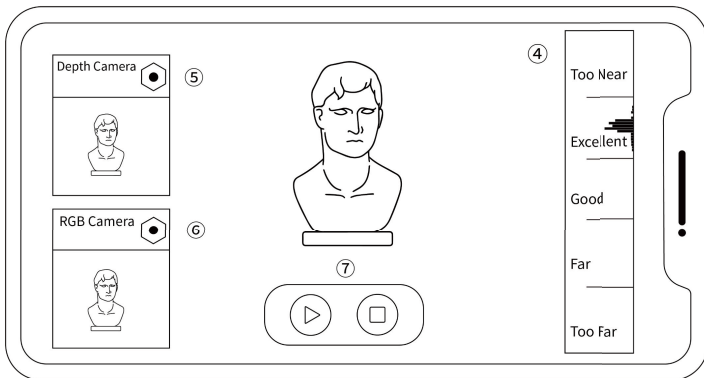

- ① Open Revo Scan on your phone and tap the **New Project** button.
- ② Choose Accuracy, Tracking Mode, and Object Type according to your needs. Choose **Color** in **Texture** if you need a color model.
- ③ Tap the **Start Scanning** button to enter the scanning preview window.
- ④ Move the scanner closer or further away from the object until the scanning distance indicator bar shows **Excellent** or **Good**.

- ⑤ Tap the  icon in the Depth Camera preview window to adjust the Depth Cameras' exposure until there are as few blue and red areas on the object in the preview window as possible.







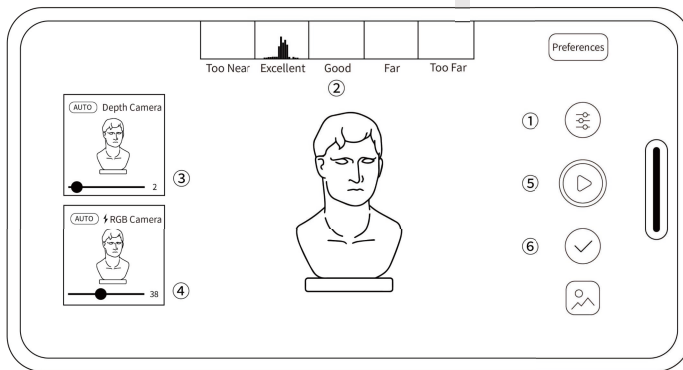

- ⑥ You must also adjust the RGB Camera's exposure when doing a color scan. Tap the  icon in the RGB Camera preview window and adjust the exposure until the object's color in the preview window is clear and sharp.
- ⑦ Tap the  icon to start scanning. Try not to scan the same areas repeatedly. Tap the  button to finish the scan and enter the post-processing window when the scan is over.
- ⑧ Fill holes in the model as required (optional).

- ⑨ Tap the **Post-processing** button for Fusing and Meshing. You can share the model to Revo Scan on your PC for more editing options. See **Sharing Models from a Phone to a PC** on page 21 of this guide for details.

Your First Scan Using Revo Scan (iOS)



- ① Tap the  icon to choose Accuracy, Tracking Mode, and Object Type. Toggle **Color Scanning** if you need a color model.

- ② Move the scanner closer or further away from the object until the scanning distance indicator bar shows **Excellent** or **Good**.
- ③ Tap the  button for the Depth Cameras' exposure to be set automatically, or you can turn off the  exposure and change the exposure by dragging the slider until there are as few blue and red areas on the object in the Depth Camera preview window as possible.
- ④ You also must adjust the RGB Camera's exposure when doing a color scan. Tap the  button for the exposure to be set automatically, or you can turn off the  exposure and adjust the exposure by dragging the slider until the object's color in the RGB preview window is clear and sharp.
- ⑤ Tap the  button to start your scan. Try not to scan the same areas repeatedly.
- ⑥ Tap the  button to finish the scan and enter the post-processing window when the scan is over.

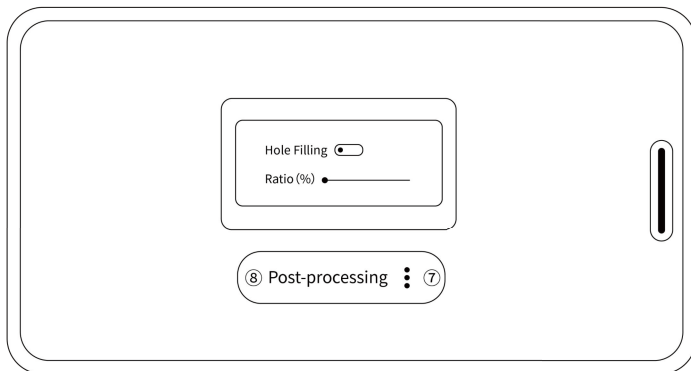

- ⑦ Tap the  icon to fill holes in the model as required (optional).
- ⑧ Tap the **Post-processing** button for Fusing and Meshing. You can share the model to Revo Scan on your PC for more editing options. See **Sharing Models from a Phone to a PC** on page 21 of this guide for details.

Sharing Models from a Phone to a PC

- ① Open Revo Scan on your PC and click the **New Project** button.
- ② Choose **File - Import from Phone** on the Menu Bar.
- ③ Open Revo Scan on your phone and find the project to transfer.
- ④ Tap the share icon and enter the share page (see the image on the right).
- ⑤ Enter the code or scan the QR code displayed on the PC.
- ⑥ Wait for the project to be transferred.

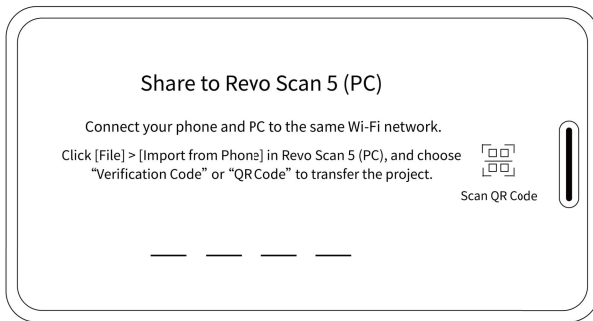

Note: The phone and PC must be connected to the same network while transferring.

IC Warning

This device complies with Industry Canada's licence-exempt RSS standard(s). Operation is subject to the following two conditions:

- (1) this device may not cause interference, and
- (2) this device must accept any interference, including interference that may cause undesired operation of the device.

Le présent appareil est conforme aux CNR d'Industrie Canada applicables aux appareils radio exempts de licence. L'exploitation est autorisée aux deux conditions suivantes:

- (1) l'appareil ne doit pas produire de brouillage, et
- (2) l'utilisateur de l'appareil doit accepter tout brouillage radioélectrique subi, même si le brouillage est susceptible d'en compromettre le fonctionnement.

This Class B digital apparatus complies with Canadian ICES-003.

Cet appareil numérique de la classe B est conforme à la norme NMB-003 du Canada.

IC RF Statement:

When using the product, maintain a distance of 20cm from the body to ensure compliance with RF exposure requirements.

Déclaration IC RF:

Lors de l'utilisation du produit, maintenez une distance de 20 cm du corps pour garantir conformité aux exigences d'exposition aux RF.

FCC Warning

This device complies with part 15 of the FCC Rules. Operation is subject to the following two conditions:

(1) This device may not cause harmful interference, and (2) this device must accept any interference received, including interference that may cause undesired operation.

Any Changes or modifications not expressly approved by the party responsible for compliance could void the user's authority to operate the equipment.

Note: This equipment has been tested and found to comply with the limits for a Class B digital device, pursuant to part 15 of the FCC Rules. These limits are designed to provide reasonable protection against harmful interference in a residential installation. This equipment generates uses and can radiate radio frequency energy and, if not installed and used in accordance with the instructions, may cause harmful interference to radio communications. However, there is no guarantee that interference will not occur in a particular installation. If this equipment does cause harmful interference to radio or television reception, which can be determined by turning the equipment off and on, the user is encouraged to try to correct the interference by one or more of the following measures:

- Reorient or relocate the receiving antenna.
- Increase the separation between the equipment and receiver.
- Connect the equipment into an outlet on a circuit different from that to which the receiver is connected.
- Consult the dealer or an experienced radio/TV technician for help.

This equipment complies with FCC radiation exposure limits set forth for an uncontrolled environment.

This equipment should be installed and operated with minimum distance 20cm between the radiator & your body.

Follow Us:



Contact Us:



Scan the QR code left with your phone and contact us for help.